



Introductions 2016

Table of Contents



Scatchard
page 3

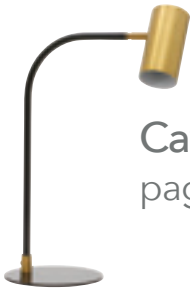

Cavendish
page 12



Delta
page 13



Geo
page 15

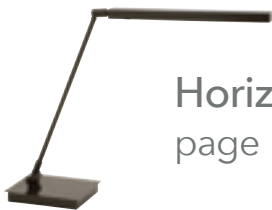

Horizon
page 15



Orbit
page 21



Otis
page 24



Direct Wire
Slim-line™
page 27



Steamer
Picture Lights
page 28



Steamer Desk
page 28

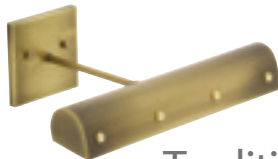

Traditional
Decorative
Picture Lights
page 32



Decorative
Desk/Piano
Lamps
page 38



Zenith LED
Picture Lights
page 41



Zenith LED
Desk/Piano
Lamps
page 41



Advent Profile
LED Picture
Lights
page 46



LED Lecturn
Lights
page 47

Scatchard Stoneware Collection

Height: 13½"
Base: 3"
Bulb: 75W Type A
Switch: On Socket
Shade: Off White Linen Hardback
6" x 8" x 7"
Cord: 10' Clear



GS50-CB
Finish: Cornflower Blue



GS50-BM
Finish: Black Matte



GS50-BG
Finish: Blue Gloss



GS50-EG
Finish: Eggplant



GS50-GG
Finish: Gray Gloss

Scatchard Stoneware Collection

Height: 13½"
Base: 3"
Bulb: 75W Type A
Switch: On Socket
Shade: Off White Linen Hardback
6" x 8" x 7"
Cord: 10' Clear



GS50-TE
Finish: Tiger's Eye



GS50-CG
Finish: Celadon Gloss



GS50-CR
Finish: Copper Red



GS50-WM
Finish: White Matte

TABLE LAMPS

Height: 19½"
Base: 8"
Bulb: 100W Type A
Switch: In-Line on Cord
Shade: Off White Linen Hardback
9" x 9" x 10"
Cord: 10' Clear



GS120-BG
Finish: Blue Gloss



GS120-BM
Finish: Black Matte



GS120-CR
Finish: Copper Red



GS120-GG
Finish: Gray Gloss



GS120-CG
Finish: Celadon Gloss



GS120-WM
Finish: White Matte

Scatchard Table Lamp

Height: 25"
Base: 5"
Bulb: 150W 3-way
Switch: On Socket
Shade: Off White Linen Softback
14" x 15" x 10"
Cord: 10" Clear



GS160-BR
Finish: Brown Gloss



GS160-CR
Finish: Copper Red



GS160-CG
Finish: Celadon Gloss



GS160-DR
Finish: Decorated Red

TABLE LAMPS

Height: 25"

Base: 5"

Bulb: 150W 3-way

Switch: On Socket

Shade: White Linen Softback
14" x 15" x 10"

Cord: 10" Clear



GS160-WG
Finish: White Gloss



GS160-EG
Finish: Eggplant



GS160-CB
Finish: Cornflower Blue

Scatchard Stoneware Shade Options

GS201

Bulb: 100W 3-Way
 Shade: Off White Linen Hardback
 9" x 9" x 10"

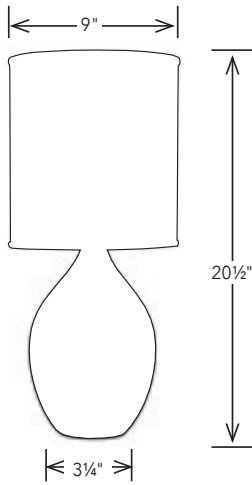

GS301

Bulb: 150W 3-Way
 Shade: Off White Linen Hardback
 11" x 11" x 12"

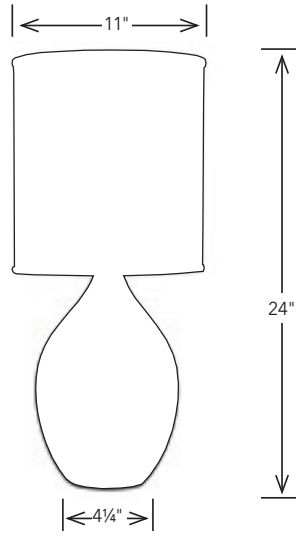

GS401

Bulb: 200W 3-Way
 Shade: Off White Linen Hardback
 13" x 13" x 14"

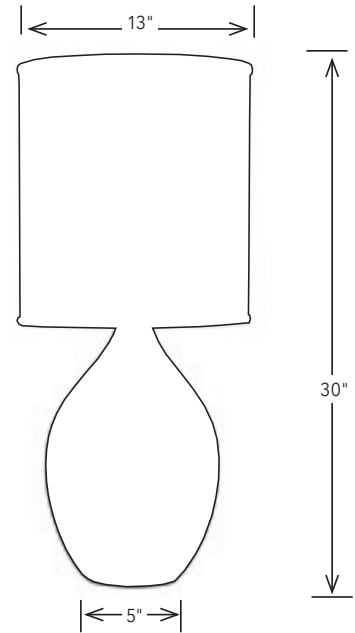

Glaze: Blue Gloss (BG)



Glaze: Black Matte (BM)



Glaze: Decorated Gray (DG)



Glaze: Gray Gloss (GG)

DRUM SHADE OPTION

Available Glazes: GS201, GS301, GS401 Series



Glaze: Celadon Gloss (CG)



Glaze: Decorated Red Gloss (DR)



Glaze: Copper Red (CR)



Glaze: Midnight Blue (MID)



Glaze: Tiger Eye (TE)



Glaze: White Matte (WM)

Scatchard Stoneware Shade Options

GS202

Bulb: 100W 3-Way
 Shade: Off White Linen Hardback
 9" x 11" x 8"

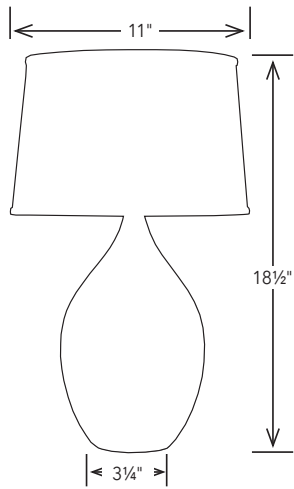

GS302

Bulb: 150W 3-Way
 Shade: Off White Linen Hardback
 12" x 14" x 9"

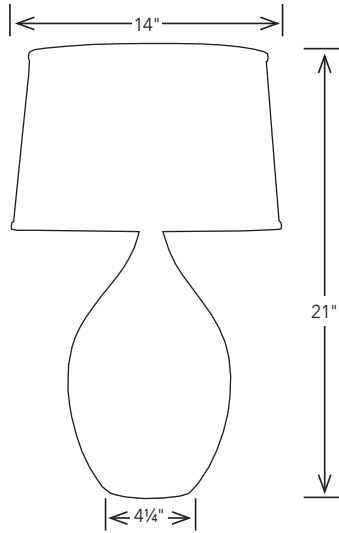

GS402

Bulb: 200W 3-Way
 Shade: Off White Linen Hardback
 14" x 16" x 10"

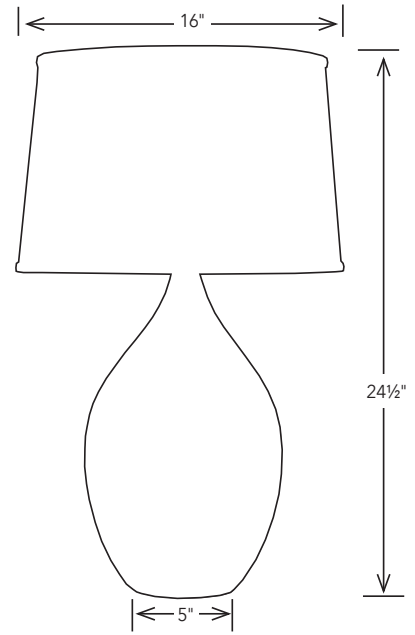

Glaze: Blue Gloss (BG)



Glaze: Black Matte (BM)



Glaze: White Matte (WM)



Glaze: Decorated Gray (DG)

TAPERED DRUM SHADE OPTION

Available Glazes: GS202, GS302, GS402 Series



Glaze: Copper Red (CR)



Glaze: Decorated Red Gloss (DR)



Glaze: Gray Gloss (GG)



Glaze: Midnight Blue (MID)



Glaze: Tiger Eye (TE)



Glaze: Celadon Gloss (CG)



Cavendish

FLOOR LAMPS

Height: Adjusts 42" to 55½"
Extension: 12"
Base: 11"
LED: 3000K, 80 CRI, 6 Watts, 500 Lumens
Included
Switch: Touch Dimmer on Shade
Shade: 3" x 5¾"
Cord: 10' Clear with Plug-in Driver

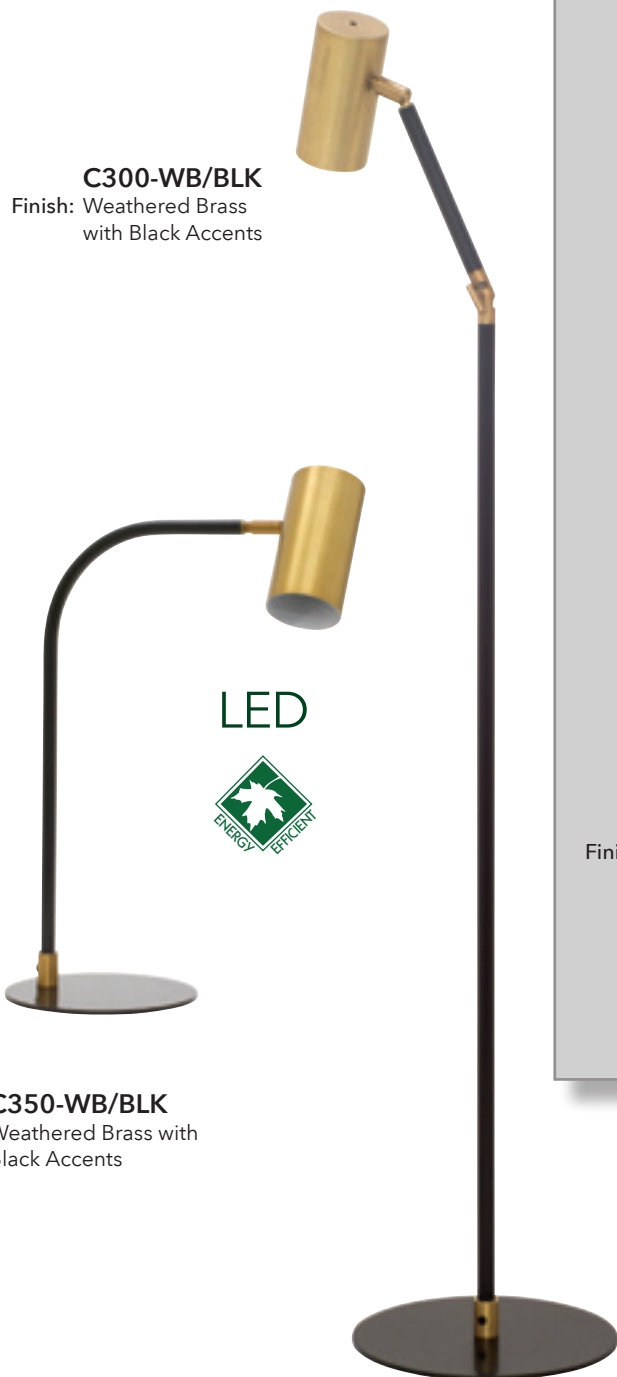

C300-WB/BLK
Finish: Weathered Brass
with Black Accents

C350-WB/BLK
Finish: Weathered Brass with
Black Accents

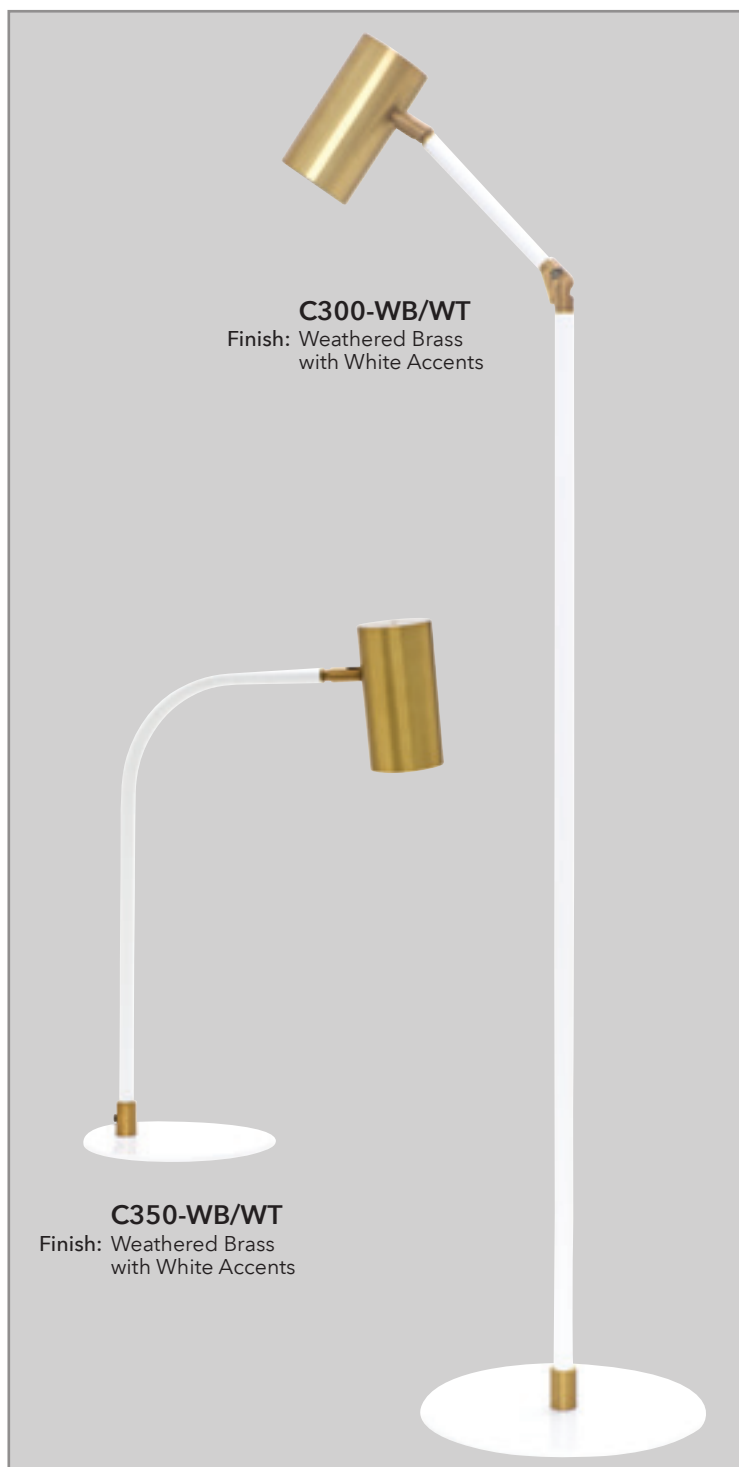

C300-WB/WT
Finish: Weathered Brass
with White Accents

C350-WB/WT
Finish: Weathered Brass
with White Accents

TABLE LAMPS

Height: 21"
Extension: 13½"
Base: 8"
LED: 3000K, 80 CRI, 6 Watts, 500 Lumens
Switch: Touch Dimmer on Shade
Shade: 3" x 5¾"
Cord: 10' Clear with Plug-in Driver

Delta

Height: Adjusts 37½" to 49½"
Extension: 20"
Base: 10"
LED: 3000K, 80 CRI, 6 Watts, 500 Lumens
Included
Switch: Touch Dimmer on Shade
Shade: 2" x 4"
Cord: 10' Clear with Plug-in Driver

LED



D100-SN
Finish: Satin Nickel



D100-AB
Finish: Antique Brass



D100-OB
Finish: Oil Rubbed Bronze



Delta

DESK LAMPS

Height: 18"
Extension: 18"
Base: 7"
LED: 3000K, 80 CRI, 6 Watts, 500 Lumens
Included
Switch: Touch Dimmer on Shade
Shade: 2" x 4"
Cord: 10' Clear with Plug-in Driver

LED



D150-OB
Finish: Oil Rubbed Bronze



D150-AB
Finish: Antique Brass



D150-SN
Finish: Satin Nickel



D175-OB
Finish: Oil Rubbed Bronze

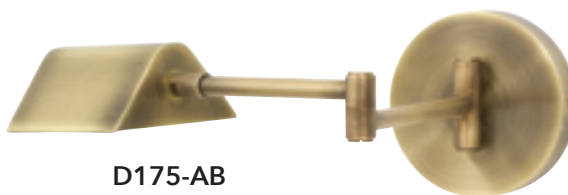

D175-AB
Finish: Antique Brass

WALL LAMPS

Height: 5½"
Extension: 21"
Backplate: 5½"
LED: 3000K, 80 CRI, 6 Watts, 500 Lumens
Included
Switch: Touch Dimmer on Shade
Shade: 2" x 4"
Cord: 10' Clear with Plug-in Driver,
with 30" cord cover



D175-SN
Finish: Satin Nickel

Finish: White with Weathered Brass Accents
Bulb: 60W B10
Switch: In-Line
Shade: White Linen Hardback
4" x 6" x 6"
Cord: 10' Clear



GEO206
Height: 12"
Base: 5"



GEO306
Height: 12"
Base: 4½"



GEO106
Height: 12"
Base: 4½"



GEO406
Height: 13"
Base: 5"

Geo

Finish: Navy Blue with Weathered Brass Accents

Bulb: 60W B10

Switch: In-Line

Shade: Cream Linen Hardback

4" x 6" x 6"

Cord: 10' Clear



GEO209

Height: 12"
Base: 5"



GEO109

Height: 12"
Base: 4½"



GEO309

Height: 12"
Base: 4½"



GEO409

Height: 13"
Base: 5"

ACCENT LAMPS

Finish: Black Matte with Chrome Accents
Bulb: 60W B10
Switch: Black In-Line
Shade: White Linen Hardback
4" x 6" x 6"
Cord: 10' Clear



GEO210
Height: 12"
Base: 5"



GEO310
Height: 12"
Base: 4½"



GEO110
Height: 12"
Base: 4½"



GEO410
Height: 13"
Base: 5"

Geo

Finish: Mahogany Bronze with Weathered Brass Accents
Bulb: 60W B10
Switch: Black In-Line
Shade: Cream Linen Hardback
4" x 6" x 6"
Cord: 10' Clear



GEO211
Height: 12"
Base: 5"



GEO311
Height: 12"
Base: 4½"



GEO111
Height: 12"
Base: 4½"



GEO411
Height: 13"
Base: 5"

Horizon LED-Z Floor

Height: Adjusts 37½" to 49½"
Extension: 20½"
Base: 10½" x 8½"
LED: 3000K, 85 CRI, 4.5 Watts, 500 Lumens
Included
Switch: On Shade
Shade: 14"
Cord: 10' Brown

LED



HLEDZ600-PG
Finish: Platinum Gray

HLEDZ600-GT
Finish: Granite

HLEDZ600-ABZ
Finish: Architectural Bronze

Horizon LED-Z Desk

Height: Adjusts 12" to 19"
Extension: 29" Maximum
Base: 7¼" x 6"
LED: 3000K, 85 CRI, 4.5 Watts, 500 Lumens
Included
Switch: On Shade
Shade: 14"
Cord: 10' Brown

LED



HLEDZ650-ABZ
Finish: Architectural Bronze



HLEDZ650-GT
Finish: Granite



HLEDZ650-PG
Finish: Platinum Gray

Height: Adjustable to 51"
Base: 10"
Bulb: 18W GU24 CFL Included
Switch: On Shade
Shade: 6"
Cord: 10' Clear



ORB100-BLK
Finish: Black



ORB100-PN
Finish: Polished Nickel



ORB100-WT
Finish: White

Orbit

Height: Adjustable to 22"
Base: 7"
Bulb: 18W GU24 CFL Included
Switch: On Shade
Shade: 6"
Cord: 10' Clear



ORB150-PN
Finish: Polished Nickel



ORB150-BLK
Finish: Black



ORB150-WT
Finish: White

TABLE/WALL LAMPS

Height: 6"
 Extension: 8¾"
 Base: 6"
 Bulb: 18W GU24 CFL Included
 Switch: On Shade
 Shade: 6"
 Cord: 10' Clear



ORB125-WT
Finish: White



ORB125-BLK
Finish: Black

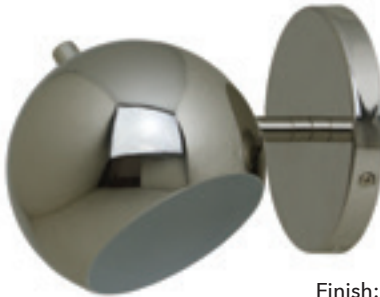

ORB125-PN
Finish: Polished Nickel

Height: 6"
 Extension: 18¾"
 Base: 6"
 Bulb: 18W GU24 CFL Included
 Switch: On Shade
 Shade: 6"
 Cord: 10' Clear



ORB175-BLK
Finish: Black



ORB175-WT
Finish: White



ORB175-PN
Finish: Polished Nickel

Otis

Height: Adjusts 49" to 67"
Extension: 23"
Base: 10"
Bulb: 60W Type A
Switch: On Socket
Shade: 2¼" x 10" x 4¾"
(Metal Shown MS)

Glass Shade Options



Amber (AM)



Green (GR)



White (WT)



OT600-SN-MS

Finish: Satin Nickel
Cord: 10' Clear

OT600-AB-MS

Finish: Antique Brass
Cord: 10' Brown

OT600-OB-MS

Finish: Oil Rubbed Bronze
Cord: 10' Brown

FLOOR/TABLE LAMPS

Height: 26"
Base: 8½"
Bulb: 60W Type A
Switch: On Socket
Shade: 2¼" × 10" × 4¾"
(Metal Shown MS)

Glass Shade Options



Amber (AM)



Green (GR)



White (WT)



OT650-AB-MS

Finish: Antique Brass
Cord: 10' Brown



OT650-OB-MS

Finish: Oil Rubbed Bronze
Cord: 10' Brown



OT650-SN-MS

Finish: Satin Nickel
Cord: 10' Clear

Otis

Height: 5"
Extension: 16½"
Base: 5"
Bulb: 60W Type A
Switch: On Socket
Shade: 2¼" x 10" x 4¾"
(Metal Shown MS)

Available in Direct Wire Only

Glass Shade Options



Amber (AM)



Green (GR)



White (WT)



OT675-OB-MS
Finish: Oil Rubbed Bronze



OT675-AB-MS
Finish: Antique Brass



OT675-SN-MS
Finish: Satin Nickel

Direct Wire Slim-line™ LED-Z Sconce

Height: 19"
Extension: 4" (**meets ADA requirements**)
Backplate: 5"
LED: 2700K, 90 CRI, 4.5 Watts, 360 Lumens
Included

LED



DSCLEDZ19-91
Finish: Oil Rubbed Bronze



DSCLEDZ19-52
Finish: Satin Nickel



DSCLEDZ19-71
Finish: Antique Brass



DSCLEDZ19-51
Finish: Satin Brass

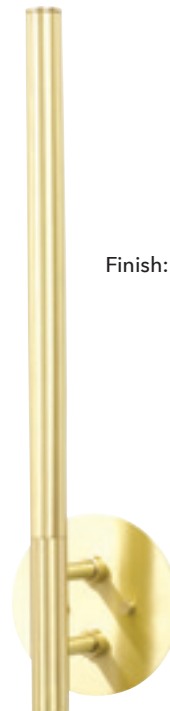

DSCLEDZ19-61
Finish: Polished Brass



Steamer Direct Wire Picture Lights

Each finish combination is available in 16", 24" & 36" lengths



DST16-MBAB

Finish: Mahogany Bronze with
Antique Brass Accents

Shade: 16"

Extension: 12½"

Backplate: 4½" x 6"

Bulb: Two 25 or 40T10F



DST30-ABMB

Finish: Antique Brass with
Mahogany Bronze Accents

Shade: 30"

Extension: 12½"

Backplate: 4½" x 20"

Bulb: Four 25 or 40T10F



DST42-SNBLK

Finish: Satin Nickel with Black Accents

Shade: 42"

Extension: 12½"

Backplate: 4½" x 32"

Bulb: Six 25 or 40T10F

Steamer Direct Wire LED Picture Lights

LED

Each finish combination is available in 16", 24" & 36" lengths



DSTLEDZ16-SNBLK

Finish: Satin Nickel with Black Accents
Shade: 16"
Extension: 12½"
Backplate: 4½" × 6"
LED: 2700K, 90 CRI, 4½ Watts, 360 Lumens Included



DSTLEDZ30-MBAB

Finish: Mahogany Bronze with
Antique Brass Accents
Shade: 30"
Extension: 12½"
Backplate: 4½" × 20"
LED: 2700K, 90 CRI, 9 Watts, 720 Lumens
Included

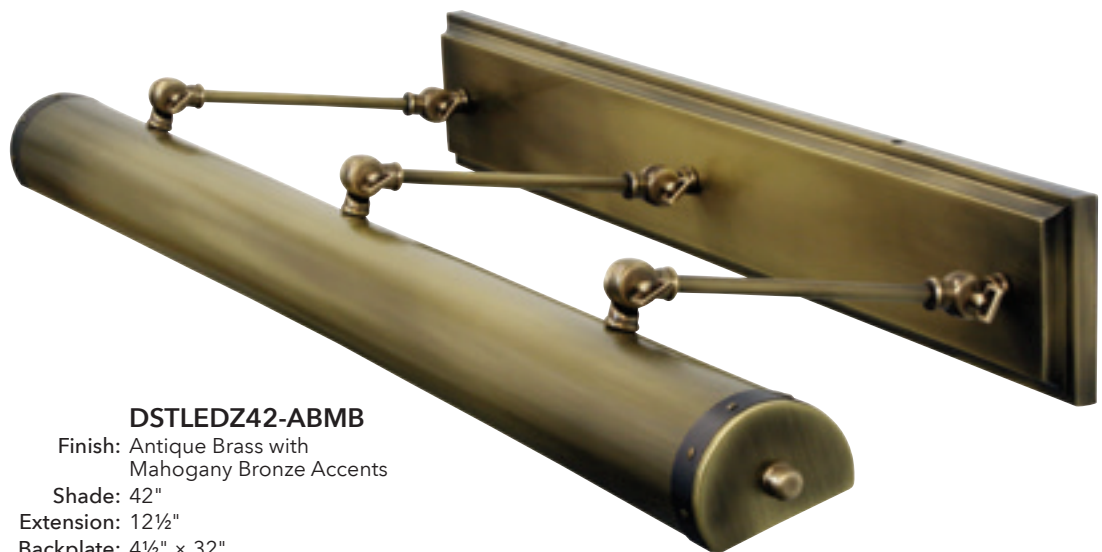

DSTLEDZ42-ABMB

Finish: Antique Brass with
Mahogany Bronze Accents
Shade: 42"
Extension: 12½"
Backplate: 4½" × 32"
LED: 2700K, 90 CRI, 13½ Watts, 1080 Lumens
Included

Steamer Desk/Piano Lamp Collection

Height: 12½"
Base: 5" Square
Bulb: 60T10
Switch: On Base
Shade: 12"

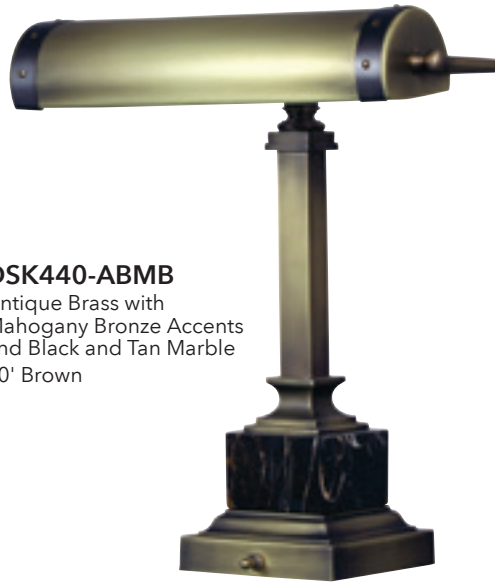

DSK440-ABMB

Finish: Antique Brass with Mahogany Bronze Accents and Black and Tan Marble
Cord: 10' Brown



DSK440-MBAC

Finish: Mahogany Bronze with Antique Copper Accents and Black and Tan Marble
Cord: 10' Brown

Marble is a natural material and therefore, each piece will have variations.

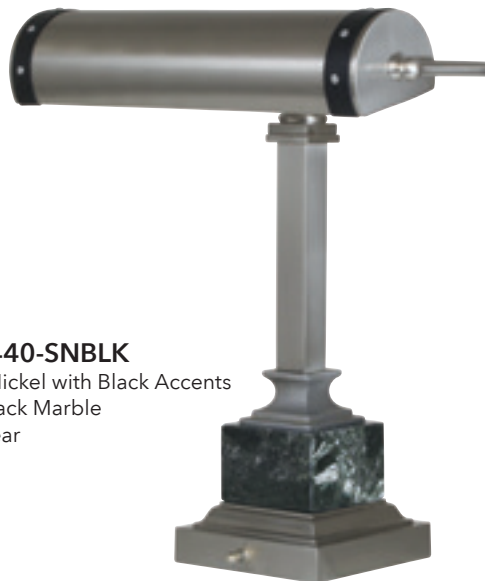

DSK440-SNBLK

Finish: Satin Nickel with Black Accents and Black Marble
Cord: 10' Clear

DESK/PIANO LAMPS

Height: 12½"
Base: 5" Square
Bulb: Two 60T10
Switch: On Base
Shade: 14"



P14-290-ABMB

Finish: Antique Brass with
Mahogany Bronze Accents
and Black and Tan Marble
Cord: 10' Brown



P14-290-MBAC

Finish: Mahogany Bronze with
Antique Copper Accents and
Black and Tan Marble
Cord: 10' Brown



P14-290-SNBLK

Finish: Satin Nickel with Black Accents
and Black Marble
Cord: 10' Clear

Traditional Direct Wire LED Picture Lights

Each finish combination is available in 14", 24" & 36" lengths

LED



DTBLEDZ14-MB/AB

Finish: Mahogany Bronze with
Antique Brass Accents

Shade: 14"

Extension: 10½"

Backplate: 4½" × 4½"

LED: 2700K, 90 CRI, 4½ Watts,
360 Lumens Included



DTBLEDZ14-AB/PB

Finish: Antique Brass with Polished Brass Accents

Shade: 14"

Extension: 10½"

Backplate: 4½" × 4½"

LED: 2700K, 90 CRI, 4½ Watts, 360 Lumens
Included



DTBLEDZ24-BLK/PN

Finish: Black with Polished Nickel Accents

Shade: 24"

Extension: 10½"

Backplate: 4" × 15"

LED: 2700K, 90 CRI, 9 Watts, 720 Lumens
Included



DTBLEDZ36-SN/PN

Finish: Satin Nickel with Polished Nickel Accents

Shade: 36"

Extension: 10½"

Backplate: 4" × 15"

LED: 2700K, 90 CRI, 13½ Watts, 1080 Lumens
Included

PICTURE LIGHTS

LED



Each finish combination is available in 14", 24" & 36" lengths

DTRLEDZ14-AB/PB

Finish: Antique Brass with Polished Brass Accents
Shade: 14"
Extension: 10½"
Backplate: 4½" × 4½"
LED: 2700K, 90 CRI, 4½ Watts, 360 Lumens Included



DTRLEDZ14-SN/PN

Finish: Satin Nickel with Polished Nickel Accents
Shade: 14"
Extension: 10½"
Backplate: 4½" × 4½"
LED: 2700K, 90 CRI, 4½ Watts, 360 Lumens Included



DTRLEDZ24-BLK/PN

Finish: Black with Polished Nickel Accents
Shade: 24"
Extension: 10½"
Backplate: 4" × 15"
LED: 2700K, 90 CRI, 9 Watts, 720 Lumens Included



DTRLEDZ36-MB/AB

Finish: Mahogany Bronze with Antique Brass Accents
Shade: 36"
Extension: 10½"
Backplate: 4" × 15"
LED: 2700K, 90 CRI, 13½ Watts, 1080 Lumens Included

Traditional Direct Wire LED Picture Lights

Each finish combination is available in 14", 24" & 36" lengths

LED



DTSLEDZ14-AB/PB

Finish: Antique Brass with Polished Brass Accents
Shade: 14"
Extension: 10½"
Backplate: 4½" × 4½"
LED: 2700K, 90 CRI, 4½ Watts, 360 Lumens Included

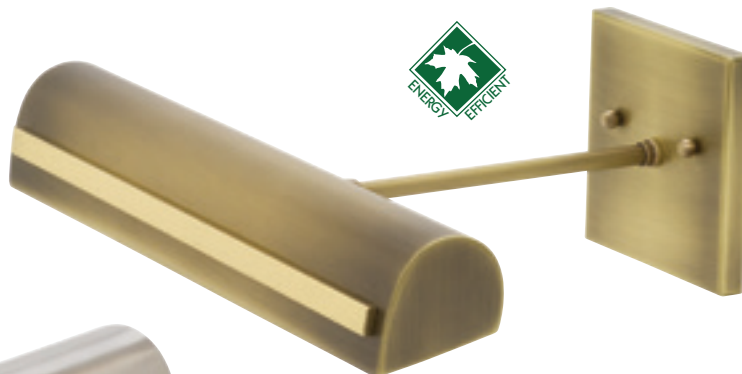

DTSLEDZ14-SN/PN

Finish: Satin Nickel with Polished Nickel Accents
Shade: 14"
Extension: 10½"
Backplate: 4½" × 4½"
LED: 2700K, 90 CRI, 4½ Watts, 360 Lumens Included

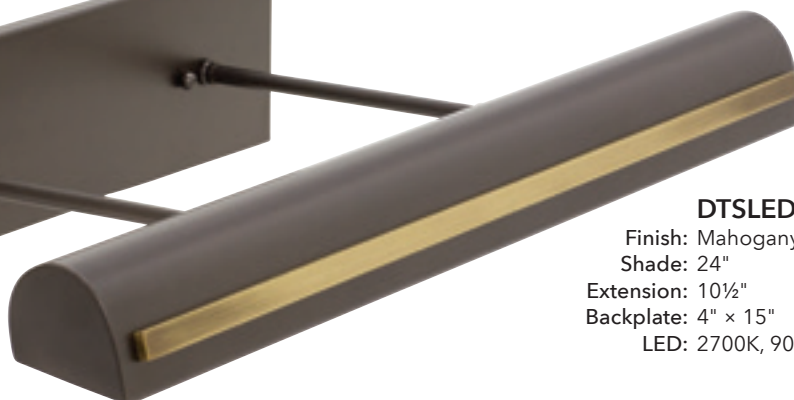

DTSLEDZ24-MB/AB

Finish: Mahogany Bronze with Antique Brass Accents
Shade: 24"
Extension: 10½"
Backplate: 4" × 15"
LED: 2700K, 90 CRI, 9 Watts, 720 Lumens Included



DTSLEDZ36-BLK/PN

Finish: Black with Polished Nickel Accents
Shade: 36"
Extension: 10½"
Backplate: 4" × 15"
LED: 2700K, 90 CRI, 13½ Watts, 1080 Lumens Included

Traditional Picture Lights

Each finish combination is available in 8", 14", 21", 24", 30" & 36" lengths



TB8-MB/AB

Finish: Mahogany Bronze with Antique Brass Accents
Shade: 8"
Extension: Adjusts from 7" to 9"
Bulb: One 25 or 40T10F
Cord: 8' Ivory with Hi-Lo In-line switch

TB14-SN/PN

Finish: Satin Nickel with Polished Nickel Accents
Shade: 14"
Extension: Adjusts from 7" to 9"
Bulb: Two 25 or 40T10F
Cord: 8' Ivory with Hi-Lo In-line switch

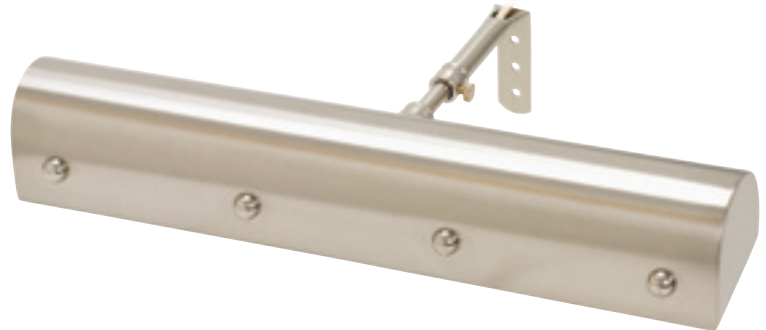

TB24-BLK/PN

Finish: Black with Polished Nickel Accents
Shade: 24"
Extension: Adjusts from 7" to 9"
Bulb: Three 25 or 40T10F
Cord: 8' Ivory with Hi-Lo In-line switch



TB36-AB/PB

Finish: Antique Brass with Polished Brass Accents
Shade: 36"
Extension: Adjusts from 7" to 9"
Bulb: Five 25 or 40T10F
Cord: 8' Ivory with Hi-Lo In-line switch



Traditional Picture Lights

Each finish combination is available in 8", 14", 21", 24", 30" & 36" lengths



TR8-BLK/PN

Finish: Black with Polished Nickel Accents
Shade: 8"
Extension: Adjusts from 7" to 9"
Bulb: One 25 or 40T10F
Cord: 8' Ivory with Hi-Lo In-line switch



TR14-AB/PB

Finish: Antique Brass with Polished Brass Accents
Shade: 14"
Extension: Adjusts from 7" to 9"
Bulb: Two 25 or 40T10F
Cord: 8' Ivory with Hi-Lo In-line switch



TR24-SN/PN

Finish: Satin Nickel with Polished Nickel Accents
Shade: 24"
Extension: Adjusts from 7" to 9"
Bulb: Three 25 or 40T10F
Cord: 8' Ivory with Hi-Lo In-line switch



TR36-MB/AB

Finish: Mahogany Bronze with Antique Brass Accents
Shade: 36"
Extension: Adjusts from 7" to 9"
Bulb: Five 25 or 40T10F
Cord: 8' Ivory with Hi-Lo In-line switch

PICTURE LIGHTS

Each finish combination is available in 8", 14", 21", 24", 30" & 36" lengths



TS8-MB/AB

Finish: Mahogany Bronze with Antique Brass Accents
Shade: 8"
Extension: Adjusts from 7" to 9"
Bulb: One 25 or 40T10F
Cord: 8' Ivory with Hi-Lo In-line switch



TS14-BLK/PN

Finish: Black with Polished Nickel Accents
Shade: 14"
Extension: Adjusts from 7" to 9"
Bulb: Two 25 or 40T10F
Cord: 8' Ivory with Hi-Lo In-line switch



TS24-SN/PN

Finish: Satin Nickel with Polished Nickel Accents
Shade: 24"
Extension: Adjusts from 7" to 9"
Bulb: Three 25 or 40T10F
Cord: 8' Ivory with Hi-Lo In-line switch



TS36-AB/PB

Finish: Antique Brass with Polished Brass Accents
Shade: 36"
Extension: Adjusts from 7" to 9"
Bulb: Five 25 or 40T10F
Cord: 8' Ivory with Hi-Lo In-line switch

Desk/Piano Lamp

Height: Maximum 14"
Base: 6" Square
Bulb: Two 40T10 or 60T10
Switch: On Base
Shade: 14"



PB14-201-MB/AB
Finish: Mahogany Bronze with
Antique Brass Accents
Cord: 9' Brown



PR14-201-BLK/PN
Finish: Black with
Polished Nickel Accents
Cord: 9' Black



PS14-201-SN/PN
Finish: Satin Nickel with
Polished Nickel Accents
Cord: 9' Clear



PS14-201-AB/PB
Finish: Antique Brass with
Polished Brass Accents
Cord: 9' Brown

DESK/PIANO LAMP

Height: Maximum 13"
Base: 5" Square
Bulb: Two 40T10 or 60T10
Switch: On Base
Shade: 14"



PB14-202-BLK/PN
Finish: Black with
Polished Nickel Accents
Cord: 9' Black



PB14-202-SN/PN
Finish: Satin Nickel with
Polished Nickel Accents
Cord: 9' Clear



PR14-202-AB/PB
Finish: Antique Brass with
Polished Brass Accents
Cord: 9' Brown



PS14-202-MB/AB
Finish: Mahogany Bronze with
Antique Brass Accents
Cord: 9' Brown

Desk/Piano Lamp

Height: Maximum 12½"
Base: 6" Octagon
Bulb: Two 40T10 or 60T10
Switch: On Base
Shade: 14"



PR14-203-MB/AB
Finish: Mahogany Bronze with
Antique Brass Accents
Cord: 9' Brown



PB14-203-AB/PB
Finish: Antique Brass with
Polished Brass Accents
Cord: 9' Brown





PR14-203-SN/PN
Finish: Satin Nickel with
Polished Nickel Accents
Cord: 9' Clear



PS14-203-BLK/PN
Finish: Black with
Polished Nickel Accents
Cord: 9' Brown

Zenith Direct Wire LED Picture Lights

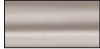
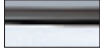
Finishes

-  Satin Brass #51
-  Satin Nickel #52
-  Chrome #62
-  Antique Brass #71
-  Oil Rubbed Bronze #91

LED



DZLEDZ12-62

Finish: Chrome
Shade: 12"
Extension: 10½"
Backplate: 4½" × 4½"
LED: 2700K, 90 CRI, 4½ Watts,
360 Lumens Included



DZLEDZ24-52

Finish: Satin Nickel
Shade: 24"
Extension: 10½"
Backplate: 4½" × 8"
LED: 2700K, 90 CRI, 9 Watts,
720 Lumens Included



DZLEDZ36-51

Finish: Satin Brass
Shade: 36"
Extension: 10½"
Backplate: 4½" × 8"
LED: 2700K, 90 CRI, 13½ Watts,
1080 Lumens Included

Zenith Collection

LED



Finishes

	Satin Brass #51
	Satin Nickel #52
	Chrome #62
	Antique Brass #71
	Oil Rubbed Bronze #91



ZLEDZ12-71

Finish: Antique Brass
Shade: 12"
Extension: 10"
Switch: In-line
LED: 2700K, 90 CRI, 4½ Watts,
360 Lumens Included
Cord: 8' Ivory



ZLEDZ24-51

Finish: Satin Brass
Shade: 24"
Extension: 10"
Switch: In-line
LED: 2700K, 90 CRI, 9 Watts,
720 Lumens Included
Cord: 8' Ivory



ZLEDZ36-91

Finish: Oil Rubbed Bronze
Shade: 36"
Extension: 10"
Switch: In-line
LED: 2700K, 90 CRI, 13½ Watts,
1080 Lumens Included
Cord: 8' Ivory

PICTURE LIGHTS/DESK/PIANO LIGHTS

Height: 14"
Extension: 8"
Base: 7"
LED: 3000K, 85 CRI, 4½ Watts, 500 Lumens
Included
Switch: Full Range Dimmer on Base
Shade: 12"

LED



PZLEDZ100-52

Finish: Satin Nickel
Cord: 10' Clear



PZLEDZ100-71

Finish: Antique Brass
Cord: 10' Brown



PZLEDZ100-7

Finish: Black
Cord: 10' Black

Zenith Collection

Height: 4½"
Extension: 8"
Base: 7"
LED: 3000K, 85 CRI, 4½ Watts, 500 Lumens
Included
Switch: Full Range Dimmer on Base
Shade: 12"

LED



PZLEDZ101-52

Finish: Satin Nickel
Cord: 10' Clear



PZLEDZ101-7

Finish: Black
Cord: 10' Black



PZLEDZ101-71

Finish: Antique Brass
Cord: 10' Brown



PIANO LAMPS

Height: 4"
Extension: 5"
Base: 5½" x 2½"
LED: 3000K, 85 CRI, 4½ Watts, 500 Lumens
Included
Switch: In-Line, 3" from clamp

LED



GPZLEDZ12-61

Finish: Polished Brass
Shade: 12"
Cord: 9' Brown



GPZLEDZ12-7

Finish: Black
Shade: 12"
Cord: 9' Black



GPZLEDZ24-61

Finish: Polished Brass
Shade: 24"
Cord: 9' Brown



GPZLEDZ24-7

Finish: Black
Shade: 24"
Cord: 9' Black

Advent Profile LED Picture Lights

Finishes

-  Black #7
-  Satin Nickel #52
-  Polished Brass #61
-  Antique Brass #71
-  Oil Rubbed Bronze #91 **(New Finish)**



Benefits of LED

- No UV or IR
- Energy Efficient
- LED Life: 30,000 Hours
- 3000K, 85 CRI



APL9-52
one 2 Watt, 140 Lumen
bi-pin LED included



APL16-91
two 2 Watt, 140 Lumen
bi-pin LEDs included



Plug-In Driver (will not fit
into recessed outlet)
1¾"W x 2¾"H x 7/8"D



APL25-71
three 2 Watt, 140 Lumen
bi-pin LEDs included

SIZE SELECTION GUIDE

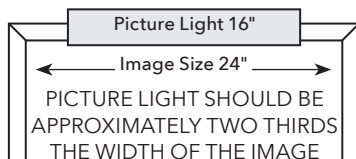

Shade removes for easy bulb replacement
and rotates for light adjustment on all
Advent Profile Picture Lights

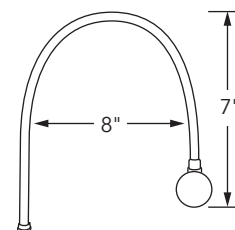
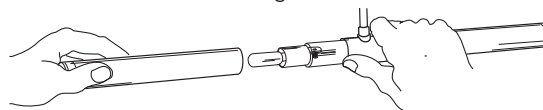



LED Lectern Light

Plug In

Height: 7½"
Extension: 5½"
LED: 2700K, 90 CRI, 4.5 Watts, 360 Lumens
Included
Switch: On Shade
Shade: 12"
Cord: 10' Brown with Snap On Plug



Finishes

-  Black #7
-  Antique Brass #71

LCLEDZ12-7
Finish: Black



LCLEDZ12-71
Finish: Antique Brass



Designed to be permanently installed on surfaces up to 2" thick.

Battery Operated

Height: 7¼"
Extension: 5¼"
LED: 3000K, 80 CRI, 1 Watts, 35 Lumens Included
Switch: In Shade
Shade: 7"
Batteries: 4 AA (Not Included), illuminates 36-48 hours



LABLED7-7
Finish: Black



LABLED7-71
Finish: Antique Brass

INDEX

ITEM	PAGE	ITEM	PAGE	ITEM	PAGE	ITEM	PAGE	ITEM	PAGE
APL9-7	46	DTSLEDZ14-AB/PB	34	GS201-DR	9	ORB175-BLK	23	TB24-MB/AB	35
APL9-52	46	DTSLEDZ14-BLK/PN	34	GS201-GG	8	ORB175-PN	23	TB24-SN/PN	35
APL9-61	46	DTSLEDZ14-MB/AB	34	GS201-MID	9	ORB175-WT	23	TB30-AB/PB	35
APL9-71	46	DTSLEDZ14-SN/PN	34	GS201-TE	9	OT600-AB-AM	24	TB30-BLK/PN	35
APL9-91	46	DTSLEDZ24-AB/PB	34	GS201-WM	9	OT600-AB-GR	24	TB30-MB/AB	35
APL16-91	46	DTSLEDZ24-BLK/PN	34	GS202-BG	10	OT600-AB-MS	24	TB30-SN/PN	35
APL25-7	46	DTSLEDZ24-MB/AB	34	GS202-BM	10	OT600-AB-WT	24	TB36-AB/PB	35
APL25-52	46	DTSLEDZ24-SN/PN	34	GS202-CG	11	OT600-OB-AM	24	TB36-BLK/PN	35
APL25-61	46	DTSLEDZ36-AB/PB	34	GS202-CR	11	OT600-OB-GR	24	TB36-MB/AB	35
APL25-71	46	DTSLEDZ36-BLK/PN	34	GS202-DG	10	OT600-OB-MS	24	TB36-SN/PN	35
APL25-91	46	DTSLEDZ36-MB/AB	34	GS202-DR	11	OT600-OB-WT	24	TR8-AB/PB	36
C300-WB/BLK	12	DTSLEDZ36-SN/PN	34	GS202-GG	11	OT600-SN-AM	24	TR8-BLK/PN	36
C300-WB/WT	12	DZLEDZ12-51	41	GS202-MID	11	OT600-SN-GR	24	TR8-MB/AB	36
C350-WB/BLK	12	DZLEDZ12-52	41	GS202-TE	11	OT600-SN-MS	24	TR8-SN/PN	36
C350-WB/WT	12	DZLEDZ12-62	41	GS202-WM	10	OT600-SN-WT	24	TR14-AB/PB	36
D100-AB	13	DZLEDZ12-71	41	GS301-BG	8	OT650-AB-AM	25	TR14-BLK/PN	36
D100-OB	13	DZLEDZ12-91	41	GS301-BM	8	OT650-AB-GR	25	TR14-MB/AB	36
D100-SN	13	DZLEDZ24-51	41	GS301-CG	9	OT650-AB-MS	25	TR14-SN/PN	36
D150-AB	14	DZLEDZ24-52	41	GS301-CR	9	OT650-AB-WT	25	TR21-AB/PB	36
D150-OB	14	DZLEDZ24-62	41	GS301-DG	8	OT650-OB-AM	25	TR21-BLK/PN	36
D150-SN	14	DZLEDZ24-71	41	GS301-DR	9	OT650-OB-GR	25	TR21-MB/AB	36
D175-AB	14	DZLEDZ24-91	41	GS301-GG	8	OT650-OB-MS	25	TR21-SN/PN	36
D175-OB	14	DZLEDZ36-51	41	GS301-MID	9	OT650-OB-WT	25	TR24-AB/PB	36
D175-SN	14	DZLEDZ36-52	41	GS301-TE	9	OT650-SN-AM	25	TR24-BLK/PN	36
DSCLEDZ19-51	27	DZLEDZ36-62	41	GS301-WM	9	OT650-SN-GR	25	TR24-MB/AB	36
DSCLEDZ19-52	27	DZLEDZ36-71	41	GS302-BG	10	OT650-SN-MS	25	TR24-SN/PN	36
DSCLEDZ19-61	27	DZLEDZ36-91	41	GS302-BM	10	OT650-SN-WT	25	TR30-AB/PB	36
DSCLEDZ19-71	27	GEO106	15	GS302-CG	11	OT675-AB-AM	26	TR30-BLK/PN	36
DSCLEDZ19-91	27	GEO109	16	GS302-CR	11	OT675-AB-GR	26	TR30-MB/AB	36
DSK440-ABMB	30	GEO110	17	GS302-DG	10	OT675-AB-MS	26	TR30-SN/PN	36
DSK440-MBAC	30	GEO111	18	GS302-DR	11	OT675-AB-WT	26	TR36-AB/PB	36
DSK440-SNBLK	30	GEO206	15	GS302-GG	11	OT675-OB-AM	26	TR36-BLK/PN	36
DST16-ABMB	28	GEO209	16	GS302-MID	11	OT675-OB-GR	26	TR36-MB/AB	36
DST16-MBAB	28	GEO210	17	GS302-TE	11	OT675-OB-MS	26	TR36-SN/PN	36
DST16-SNBLK	28	GEO211	18	GS302-WM	10	OT675-OB-WT	26	TS8-AB/PB	37
DST30-ABMB	28	GEO306	15	GS401-BG	8	OT675-SN-AM	26	TS8-BLK/PN	37
DST30-MBAB	28	GEO309	16	GS401-BM	8	OT675-SN-GR	26	TS8-MB/AB	37
DST30-SNBLK	28	GEO310	17	GS401-CG	9	OT675-SN-MS	26	TS8-SN/PN	37
DST42-ABMB	28	GEO311	18	GS401-CR	9	OT675-SN-WT	26	TS14-AB/PB	37
DST42-MBAB	28	GEO406	15	GS401-DG	8	P14-290-ABMB	31	TS14-BLK/PN	37
DST42-SNBLK	28	GEO409	16	GS401-DR	9	P14-290-MBAC	31	TS14-MB/AB	37
DSTLEDZ16-ABMB	29	GEO410	17	GS401-GG	8	P14-290-SNBLK	31	TS14-SN/PN	37
DSTLEDZ16-MBAB	29	GEO411	18	GS401-MID	9	PB14-201-MB/AB	38	TS21-AB/PB	37
DSTLEDZ16-SNBLK	29	GPZLEDZ12-7	45	GS401-TE	9	PB14-202-BLK/PN	39	TS21-BLK/PN	37
DSTLEDZ30-ABMB	29	GPZLEDZ12-61	45	GS401-WM	9	PB14-202-SN/PN	39	TS21-MB/AB	37
DSTLEDZ30-MBAB	29	GPZLEDZ24-7	45	GS402-BG	10	PB14-203-AB/PB	40	TS21-SN/PN	37
DSTLEDZ30-SNBLK	29	GPZLEDZ24-61	45	GS402-BM	10	PR14-201-BLK/PN	38	TS24-AB/PB	37
DSTLEDZ42-ABMB	29	GS50-BG	3	GS402-CG	11	PR14-202-AB/PB	39	TS24-BLK/PN	37
DSTLEDZ42-MBAB	29	GS50-BM	3	GS402-CR	11	PR14-203-MB/AB	40	TS24-MB/AB	37
DSTLEDZ42-SNBLK	29	GS50-CB	3	GS402-DG	10	PR14-203-SN/PN	40	TS24-SN/PN	37
DTBLEDZ14-AB/PB	32	GS50-CG	4	GS402-DR	11	PS14-201-AB/PB	38	TS30-AB/PB	37
DTBLEDZ14-BLK/PN	32	GS50-CR	4	GS402-GG	11	PS14-201-SN/PN	38	TS30-BLK/PN	37
DTBLEDZ14-MB/AB	32	GS50-EG	3	GS402-MID	11	PS14-202-MB/AB	39	TS30-MB/AB	37
DTBLEDZ14-SN/PN	32	GS50-GG	3	GS402-TE	11	PS14-203-BLK/PN	40	TS30-SN/PN	37
DTBLEDZ24-AB/PB	32	GS50-TE	4	GS402-WM	10	PZLEDZ100-7	43	TS36-AB/PB	37
DTBLEDZ24-BLK/PN	32	GS50-WM	4	HLEDZ600-ABZ	19	PZLEDZ100-52	43	TS36-BLK/PN	37
DTBLEDZ24-MB/AB	32	GS120-BG	5	HLEDZ600-GT	19	PZLEDZ100-71	43	TS36-MB/AB	37
DTBLEDZ24-SN/PN	32	GS120-BM	5	HLEDZ600-PG	19	PZLEDZ101-7	44	TS36-SN/PN	37
DTBLEDZ36-AB/PB	32	GS120-CG	5	HLEDZ650-ABZ	20	PZLEDZ101-52	44	ZLEDZ12-51	42
DTBLEDZ36-BLK/PN	32	GS120-CR	5	HLEDZ650-PG	20	PZLEDZ101-71	44	ZLEDZ12-52	42
DTBLEDZ36-MB/AB	32	GS120-GG	5	HLEDZ650-PG	20	TB8-AB/PB	35	ZLEDZ12-62	42
DTBLEDZ36-SN/PN	32	GS120-WM	5	LABLED7-7	47	TB8-BLK/PN	35	ZLEDZ12-71	42
DTRLEDZ14-AB/PB	33	GS160-BR	6	LABLED7-71	47	TB8-MB/AB	35	ZLEDZ12-91	42
DTRLEDZ14-BLK/PN	33	GS160-CB	7	LCLEDZ12-7	47	TB8-SN/PN	35	ZLEDZ24-51	42
DTRLEDZ14-MB/AB	33	GS160-CG	6	LCLEDZ12-71	47	TB14-AB/PB	35	ZLEDZ24-52	42
DTRLEDZ14-SN/PN	33	GS160-CR	6	ORB100-BLK	21	TB14-BLK/PN	35	ZLEDZ24-62	42
DTRLEDZ24-AB/PB	33	GS160-DR	6	ORB100-PN	21	TB14-MB/AB	35	ZLEDZ24-71	42
DTRLEDZ24-BLK/PN	33	GS160-EG	7	ORB100-WT	21	TB14-SN/PN	35	ZLEDZ24-91	42
DTRLEDZ24-MB/AB	33	GS160-WG	7	ORB125-BLK	23	TB21-AB/PB	35	ZLEDZ36-51	42
DTRLEDZ24-SN/PN	33	GS201-BG	8	ORB125-PN	23	TB21-BLK/PN	35	ZLEDZ36-52	42
DTRLEDZ36-AB/PB	33	GS201-BM	8	ORB125-WT	23	TB21-MB/AB	35	ZLEDZ36-62	42
DTRLEDZ36-BLK/PN	33	GS201-CR	9	ORB150-BLK	22	TB21-SN/PN	35	ZLEDZ36-71	42
DTRLEDZ36-MB/AB	33	GS201-CG	9	ORB150-PN	22	TB24-AB/PB	35	ZLEDZ36-91	42
DTRLEDZ36-SN/PN	33	GS201-DG	8	ORB150-WT	22	TB24-BLK/PN	35		